

Powermat 700

The new generation of moulding and planing





WEINIG offers more

Whoever buys a WEINIG machine today knows that they are optimally equipped for the future of their business.

100% quality – WEINIG machines must satisfy the highest standards. That is why the greatest care in development and manufacturing is a traditional virtue at WEINIG. You benefit from this by the long service life of your valuable investment.

Reliability – The availability of a machine determines how profitable your business is. WEINIG systems are known for their high standard. More than 80,000 machines from WEINIG are operating around the globe to the utmost satisfaction of our customers.

Expert advice – Whether you need the expertise of WEINIG Concept for turn-key solutions or the know-how of a WEINIG expert at your door – you can always rely on our committed sales team. Ultimately you will have a customized solution that offers you maximum value for your investment.

Everything from a single source – With WEINIG you have an experienced full service provider as your partner. From rough cutting to stacking, from a stand-alone machine to a fully automated turnkey production line. Including, of course, a comprehensive service package.

Service – Safety is reassuring. If worse comes to worst, our trained service engineers will be quickly on site. WEINIG maintains a unique closely woven service network worldwide. A mesh so fine that no customer can fall through!

The WEINIG ExpoCenter
In our ExpoCenter we can show you what top technology can really do for you. Here you can experience our machines in action.

Gain more value from your business: The new Powermat 700



With the introduction of the Powermat series in the year 2004 WEINIG began a new era for planing and profiling. Now, with the Powermat 700 the next generation has arrived; offering undreamt-of possibilities.

The Powermat 700 is designed with a revolutionary new operating concept which no other moulder can offer. The result: improved ease of operation and very short setup times offer the highest degree of flexibility. With these outstanding qualities the new Powermat is the perfect response to the market demands of today and sets a new standard for four sided processing.

Unique operating capability. Innovative technology. Would you have expected anything less from WEINIG?

Excellent ease of operation

The new operating concept Comfort Set comprises a great number of wrench-free adjustments for pressure and guiding elements which can be performed quickly, accurately and without error. With features like this the machine operator will experience a new degree of comfort in performing the moulder setup like he never experienced before. The final proof of the new setup procedure can also be seen in the quality of the products you produce.

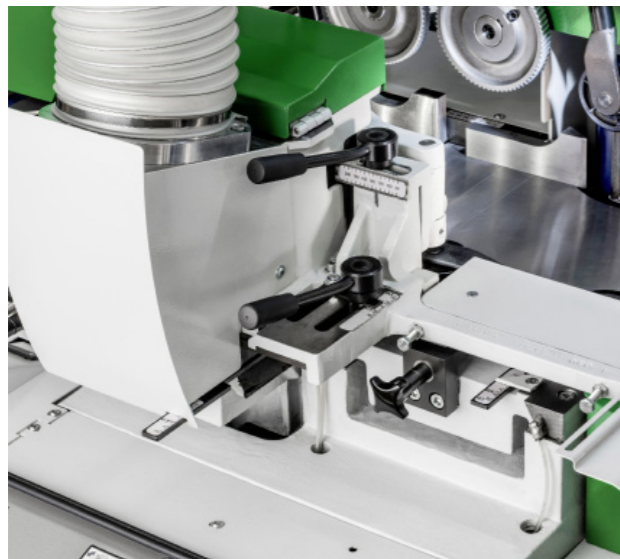

Enormous savings in set-up time

One of the primary benefits of this operating concept lies in reducing setup and idle time to a minimum. Additional potential in this area can be realized through proven optional equipment such as the PowerLock tool clamping system. With this, the full flexibility of the Powermat can be realized and even frequent tool changes or short production runs will not have a negative effect on the economic efficiency of your production.



High resource efficiency

The preservation and efficient use of resources is one of the strongest trends of our time. In the past WEINIG has always taken this aspect into account when designing new products and now even more so in the new Powermat generation. In addition to the use of energy efficient IE3 motors special attention was given to develop a new concept for the dust extraction system. The optimized flow of dust and chips reduces the performance requirements of the dust extraction system and therefore reduces the consumption of energy.

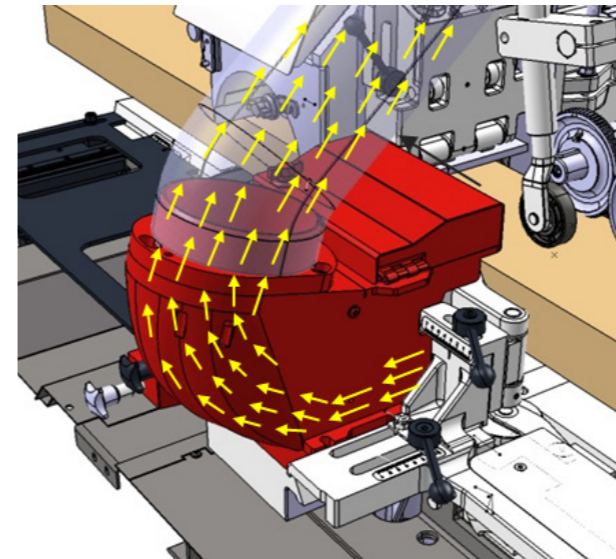

Excellent safety features

The outstanding accessibility of the Powermat enables all adjustments to be performed from the front side of the machine with ease – a large number of these are even wrench-free. Through the clear view and practical layout of the operating elements within the enclosure is the operator's safety ensured. During production the access door of the Powermat is locked according to safety regulations. Through the large window a full view of the working area is assured.

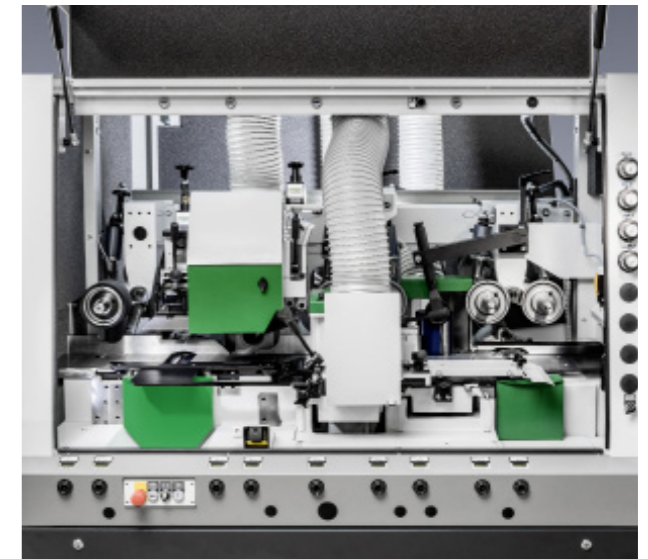

The WEINIG system: Integrated organization of the machine infrastructure

The WEINIG System enhances your Powermat 700 to become a highly efficient machining center that raises productivity. The individual system modules fit together like building blocks to produce the perfect result. From tool preparation to moulder set-up. You can make your own knives and sharpen them with the Rondamat tool grinder. The advantages for you: this makes you independent from tool services and shortens your delivery times. The OptiControl measuring system and PC located in your tool room are used to determine tool measurements and enter profile data. This information is automatically transferred to the machine PC, which saves the values and provides these via the PowerCom controls to the spindles. Then simply press a button to start production of the profile. So simple, fast and repeatable at any time - that is production with the WEINIG system!

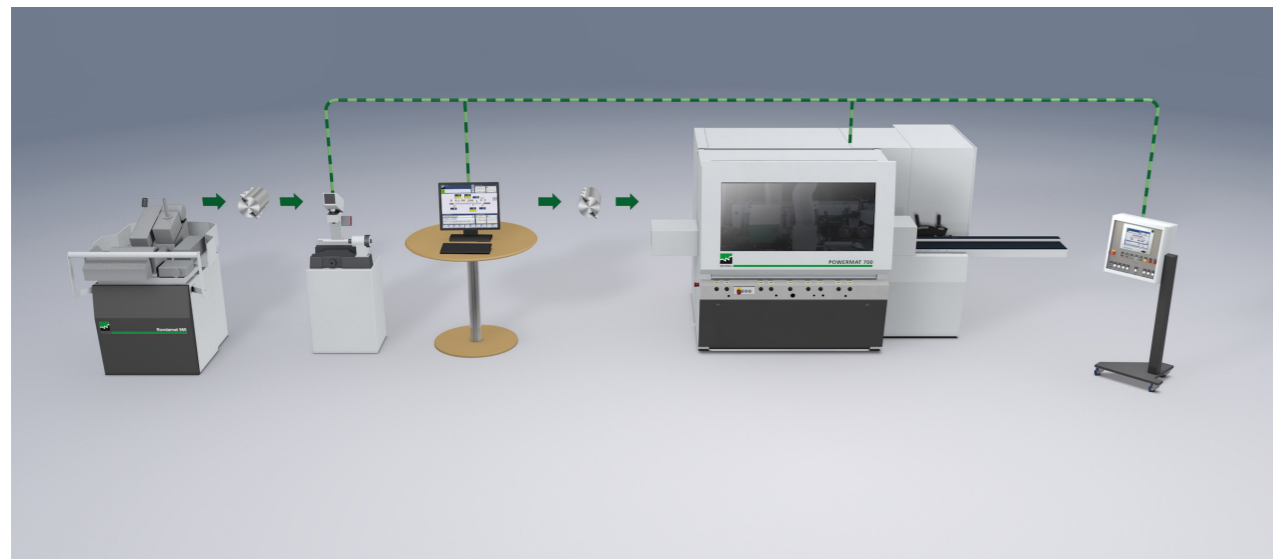
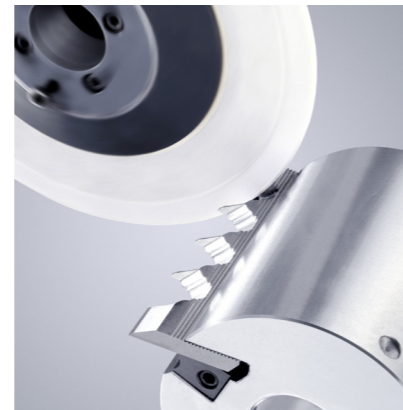

The extraordinary standards of the Powermat

With the Comfort Set operating concept you have all trump cards in one hand: optimal accessibility and comfortable machine setting ensure safe and fast setup with high quality results.



With the help of Memory Plus it is possible to perform dimensional or profile changes in the wink of an eye. All settings can be stored for perfect repetition of the product at a later date.



With 7,000 rpm spindle speed the new Powermat offers even more performance. This means more linear production every day without sacrificing high surface quality.



Technical data

WEINIG planers and moulders offer a variety of spindle configurations. This means they can be specified perfectly to your particular application.

Please note: The dimensions given here are the values for a standard machine. Other configurations are possible with options or modified position of the control cabinet.

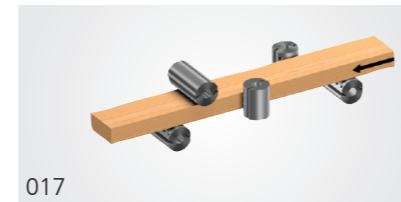
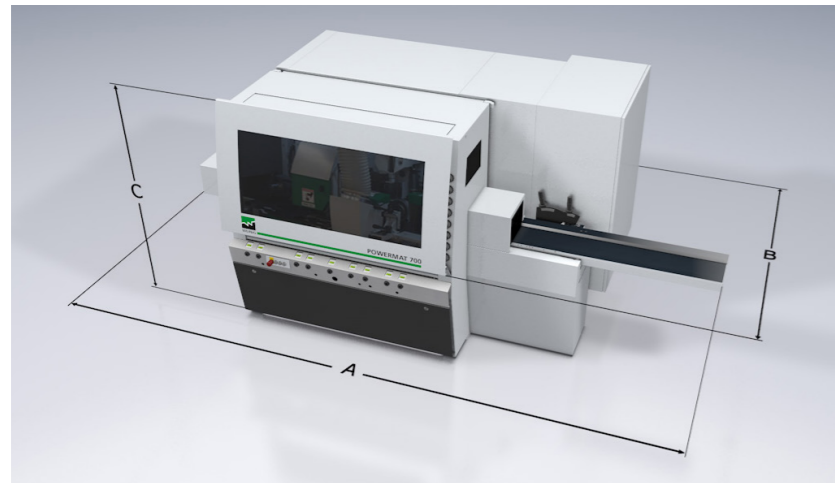

017
A = 3,820 mm (150.4"), B = 1,805 - 2,155 mm (71" - 84.8"), C = 1,900 mm (74.8")



018
A = 4,360 mm (171.6"), B = 1,805 - 2,155 mm (71" - 84.8"), C = 1,900 mm (74.8")

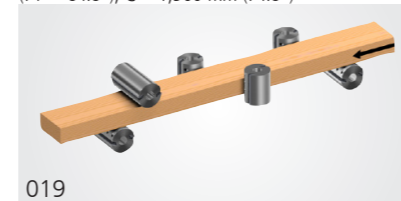

019
A = 4,255 mm (167.5"), B = 1,805 - 2,155 mm (71" - 84.8"), C = 1,900 mm (74.8")

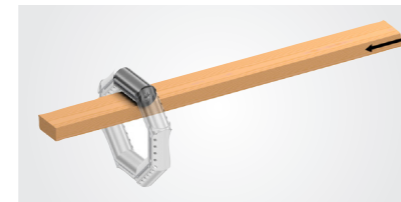

A = 800 mm (31.5")

Universal spindle

A useful addition for the production of complex profiles in one pass. Can be used in a wide range of applications and combined with other spindle configurations.

Standard models and options

Working height min./max.	10/160 mm (0.39" - 6.29")
Working width min./max.	20/230 mm (0.78" - 9.05")
260 mm (10.23") working width	○
200 mm (7.87") working height	○
7,000 rpm (not first bottom)	●
8,000 rpm	○
Operating concept Comfort Set	●
Memory Plus	●
PowerCom Plus	○
Electronic read-outs on spindle radial and axial, chip breaker and pressure shoe	●
CNC-controlled axis adjustments including feed beam and universal spindle	○
Receding chip breaker, pneumatic	○
Max. horizontal tool diameter (not first bottom)	200 mm (7.87")
Max. vertical tool diameter	200 mm (7.87")
PowerLock tool holders	○
Universal tool holders	○
Frequency-controlled feed speed (standard)	5 - 40 m/min (16.4 - 131 FPM)
MarathonCoating for machine tables	○
Max. motor power on vertical spindle (standard – option)	5.5 - 15 kW (7.5 - 20 HP)
Max. motor power on horizontal spindle (standard – option)	5.5 - 15 kW (7.5 - 20 HP)
Improved sound enclosure	○

● Standard ○ Option

Subject to technical alterations. The statements and pictures provided in this brochure also include optional equipment that is not included in standard delivery. Some protective covers were removed for photographing.

MICHAEL WEINIG AG

Product Unit Profiling

Weinigstraße 2/4 · 97941 Tauberbischofsheim · Germany
Phone +49 (0) 93 41 / 86-0 · Fax +49 (0) 93 41 / 70 80
info-profiling@weinig.com · www.weinig.com

